

Dimensions

	A	B	C	D	E	F	G	H	I	J
ft-in	4'7"-4'11"	5'-5'4"	3'10"-4'2"	8'10"-8'11"	8'6"	4'	9'-9'4"	6'5"-6'9"	3'10"	7'3"-7'7"
mm	1400-1500	1520-1620	1160-1260	2700-2730	2600	1220	2750-2850	1950-2050	1180	2200-2300
	K	L	M	N	O	P	Q	R	S	
ft-in	7"-1'1"	2'3"-2'9"	7"	5'-9"	9'-1'	1'9"	1'1"	6'-9"	2'5"	
mm	180-280	680-840	180	130-230	230-310	540	330	140-220	725	

Specifications

Model	SV08-1	
Operating weight	Rubber track	lbs(kg)
Engine	Type	Water cooled 2-cylinder diesel
	Model	ZTE 67L-BV
	Output	hp(kW)/RPM
Performance	Max. digging force, bucket/arm	lbs(kN)
	Traveling speed	MPH(km/h)
	Swing speed	RPM
	Boom swing angle (L/R)	degrees
Ground contact pressure	Rubber track	PSI(kPa)
Hydraulic system	Pump capacity	GPM
		(L/min)
	Main relief set pressure	PSI(MPa)
Blade dimensions	Width X height	ft-in(mm)
Fuel tank capacity		Gals(L)

Hydraulic P.T.O.

Model	SV08-1	
	Output	GPM(L/min)
Specification	PSI(MPa)	2400RPM
Combined flow, double actions	2625(18.1)	5.2(19.6)



YANMAR SV Series Ultra-Mini Excavator

SV08-1 Output:10.3hp(7.7kw)
Operating weight:2348lbs(1065kg)

Lifting capacity

Excavator equipped with ROPS and rubber crawlers
r: Reach from swing center line : ft-in(mm)
h: Lift point height : ft-in(mm)
w: Lifting capacity : lbs(kg)
P: Load point

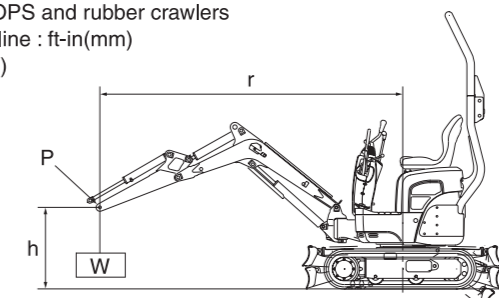
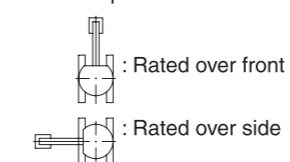

- The rated lifting capacities that are indicated below are based on ISO 10567 and do not exceed 87% of the excavator's hydraulic lifting capacity or 75% of its static tilt load (tipping load) capacity.
- The following operating criteria are also applicable to the calculation of these maximum loads:
 - The "load point" is the location of the front bolt on the arm.
 - The three indicated machine positions are :
 - arm over the front end (blade down),
 - arm over the front end (blade up), and
 - arm over the side (blade up).
 - The operating cylinder is the boom cylinder.
- The weight of the excavator's bucket, hook, sling and other lifting accessories have been taken into consideration when calculating these maximum loads.

SV08-1

LIFT POINT HEIGHT h:ft-in (mm)	r:REACH ft-in (mm)				r:REACH ft-in (mm)				r:REACH ft-in (mm)			
	RATED LIFT CAPACITY OVER FRONT BLADE DOWN lbs (kg)				RATED LIFT CAPACITY OVER FRONT BLADE UP lbs (kg)				RATED LIFT CAPACITY OVER SIDE BLADE DOWN lbs (kg)			
	MAX	6'7" (2000)	4'11" (1500)	MIN	MAX	6'7" (2000)	4'11" (1500)	MIN	MAX	6'7" (2000)	4'11" (1500)	MIN
6'7" (2000)	*485(220)				419(190)				353(160)			
4'11" (1500)	*485(220)	*485(220)	*595(270)		331(150)	375(170)	*529(240)		265(120)	331(150)	441(200)	
3'3" (1000)	*507(230)	*573(260)	*772(350)	*1080(490)	287(130)	375(170)	617(280)	838(380)	243(110)	309(140)	507(230)	662(300)
1'8" (500)	*529(240)	*662(300)	*1036(470)	*1301(590)	287(130)	375(170)	573(260)	706(320)	221(100)	287(130)	463(210)	573(260)
Ground(0)	*529(240)	*706(320)	*1058(480)	*1389(630)	309(140)	375(170)	573(260)	750(340)	243(110)	287(130)	463(210)	595(270)
-1'8" (-500)	*573(260)	*617(280)	*948(430)		375(170)	353(160)	595(270)		287(130)	287(130)	463(210)	
-3'3" (-1000)	*507(230)				*507(230)				*463(210)			

Note : The maximum loads marked with an asterisk (*) were limited by the Excavator's hydraulic lifting capacity rather than by its static tilt load (tipping load) capacity.

Standard equipment

- Blade
- Boom swing function
- Rubber tracks
- Variable undercarriage
- Auxiliary valve and piping (boom end)
- Double acting PTO
- 2way control pattern change
- Cylinder cover (boom, blade)
- Foldable ROPS
- Standard seat
- Seat belt
- Operation manual

(Please note that the standard equipment may vary from this list. Consult your Yanmar dealer for confirmation)

Note : All information presented in this Brochure is subject to change without notice.

YANMAR AMERICA CORP.

CONSTRUCTION EQUIPMENT DEPT.
101 International Parkway, Adairsville, GA 30103, U.S.A.
TEL:770-877-7570 FAX:770-877-7572
http://www.yanmar.com

A Whole New Class of Slim and Compact Convenience

Here's the new shape for simple and efficient work in confined spaces. The SV08 is a tenacious worker for narrow-spots such as housing foundations, indoor renovation, pipe laying and landscaping.

Ultra-small 2ft-5in(725mm) rear turning radius

The supremely compact body keeps rear overhang to just 1ft(305mm) during turning at maximum width, bringing even better turning performance in narrow passages.



Maneuvers through gaps of only 2ft-4in(700mm) with a vehicle width of only 2ft-3in(680mm)

(Minimum track width) The width of the ultra-mini Yanmar SV08 reduces to only 2ft-3in(680mm).

The variable undercarriage allows the left and right tracks to raise and lower independently to correct the machine's angle on slopes or steps. This small, slim unit enters easily into tight areas.

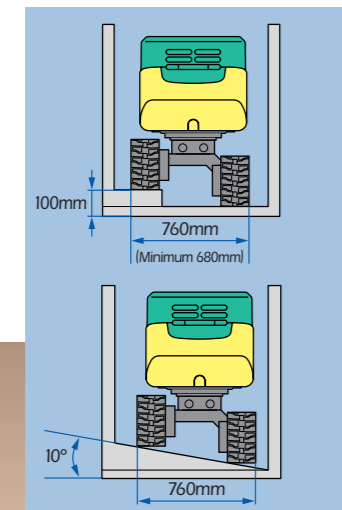

Tracks raise to 4in(100mm) for stability on slopes or steps.

The Trail-blazing Adjustable Yanmar Tracks

Adjust the track width for the job. Track width adjusts between 2ft-3in to 2ft-9in(680-840mm) Machine angle adjustment on slopes and steps

Simple folding extendable blades

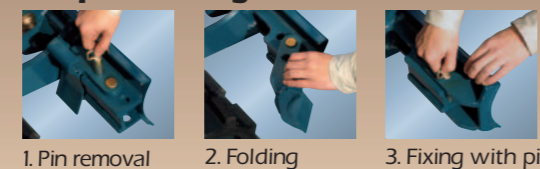

Operator Friendly - A Pleasant Way to Work

The many easy to use features include the comfortable seat with retractable seat belt, sensitive lever controls, a footrest, and uncomplicated lever arrangement.



PTO
PTO is piped to both right and left sides of the arm to enable the use of additional hydraulic attachments.



Control pattern

Two-way pattern control lever is standard equipment. (ISO Excavator ↔ Optional Backhoe controls)

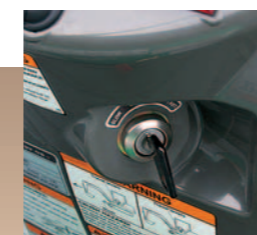

Engine key
Key start/stop system



Retractable pedals
PTO pedal and swing control pedal.

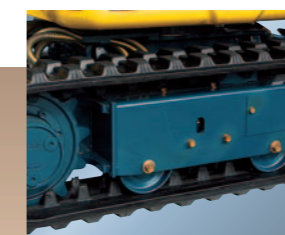

Track roller
Track rollers have an external flange which reduces the vibration during traveling.

Durable and Environmentally Friendly

Foldable ROPS with retractable seatbelt.



Hydraulic hoses are housed under the cylinders for protection from accidental damage.



Boom cylinder and hydraulic hoses are covered for protection from accidental damage.

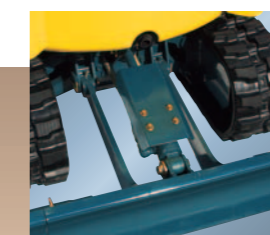

The blade hydraulic cylinder is covered by a protective shield.



Large opening engine hood and removable side frame cover provide easy accessibility for maintenance.

Easy on Environment

The advanced C&S (Clean & Silent) diesel engine features clean exhaust, powerful output, and noise of only 60dB(A) at 23ft(7 meters). (Satisfies EPA Tier II requirements.)